

MOTOR SPECIFICATIONS

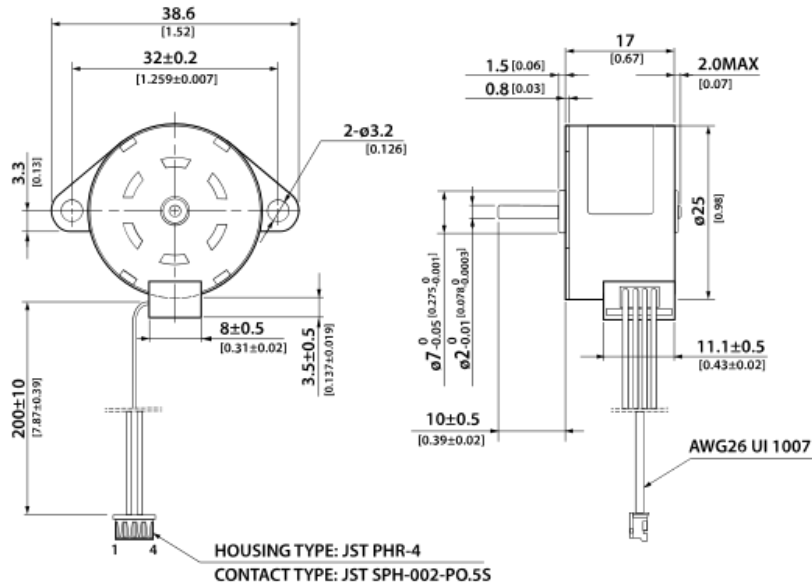

Part Number	PM25L-075-047
Rate Voltage	12
Constant Current	0.47A/Phase
Phase Number	2
Step Angle	7.5°
Excitation Method	Bipolar Full-Step
Insulation Class	Class B
Resistance per Phase	8Ω ± ? ± 10%
Inductance per Phase A/B	7.5± 20%
Holding Torque	250g-cm Min
Detent Torque	45 g-cm Max
Insulation Resistance	100M? min.Ω min.

DIMENSIONS



CONNECTOR PIN LOCATION						
PIN NO.	COLOR	CCW ← → CW (Seen from flange side)				PHASE
1	BLACK	ON		ON	ON	A
2	BROWN		ON	ON		\bar{A}
3	ORANGE	ON	ON		ON	B
4	YELLOW			ON	ON	\bar{B}

PERFORMANCE CURVE

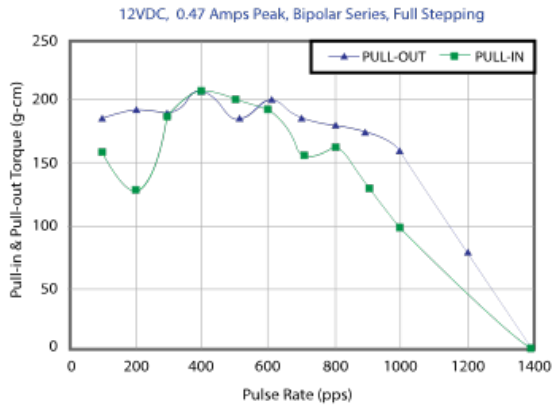

OPERATING CONDITIONS

Operating Temperature	-20°C - +50°C
Operating Humidity	15 - 85% RH
Storage Temperature	-30°C - +70°
Storage Humidity	15 - 85% RH

MECHANICAL SPECIFICATIONS

Radial Shaft Loading	5N Max
Axial Shaft Loading	1N Max
Radial Shaft Play	0.05 mm Max
Axial Shaft Play	0.6 mm Max
Mass	Approximate 39g
Rotor Inertia	Approximate 0.85 g-cm ²

OPERATION & USAGE TIPS

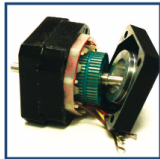

Do not disassemble motors; a significant reduction in motor performance will occur.

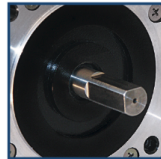

Do not machine shafts; this will have a negative effect on shaft run out and perpendicularity.

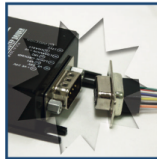

Do not disconnect motor from drive while in operation.

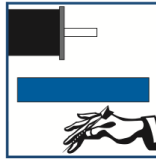

Do not use holding torque/detent torque of motor as a fail safe brake.

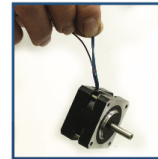

Do not hold motor by lead wires.



Do not exceed the rated current; this will burn the motor.

FAILURE TO COMPLY WITH THESE RECOMMENDATIONS WILL VOID ALL WARRANTY TERMS

RECOMMENDED



Microstepping Driver
R208



Single Axis Controller + Driver
R256-RO

Motion Control, **Solved.**

MOTOR ENGINEERING & MANUFACTURING



Optimized
For Your
Application



Quick
Prototype
Turnaround



Small Batch
to OEM Volume
Production



US Based
Support &
Manufacturing